

LED SOLAR FLOOD LIGHT RANGE



PRODUCT DETAILS



MADPLS-FL100W-6K/B



MADPLS-FL200W-6K/B



MADPLS-FL300W-6K/B

Key Features

- Solar LED Flood light
- No AC power cables, no electrical charges
- Die-Casting Aluminium body
- Polycrystalline Solar panel
- Lithium battery, Remote control
- Build-in dusk to dawn sensor

MODEL NUMBER	Wattage	Materials	LED CHIPS	LED Q'ty (pcs)	LUMENS	CCT	Solar Panel	Battery	Charging Time	Discharging Time	CRI	DIMMABLE	Warranty
MADPLS-FL100W-6K/B	100W	Die-Casting Aluminium	SMD5730	224	12000lm	6K	9V 25W	6.4V 18Ah	6-8 Hours	10-12 Hours	> 80	No	3 years
MADPLS-FL200W-6K/B	200W	Die-Casting Aluminium	SMD5730	424	24000lm	6K	18V 30W	12.8V 30Ah	6-8 Hours	10-12 Hours	> 80	No	3 years
MADPLS-FL300W-6K/B	300W	Die-Casting Aluminium	SMD5730	584	36000lm	6K	6V 65W	3.2V 96Ah	6-8 Hours	10-12 Hours	> 80	No	3 years
MADPLS-RC	Remote controller for LED solar street light, batten light and Flood light.												

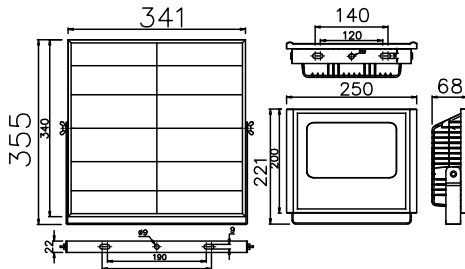

MADPLS-FL100W-B

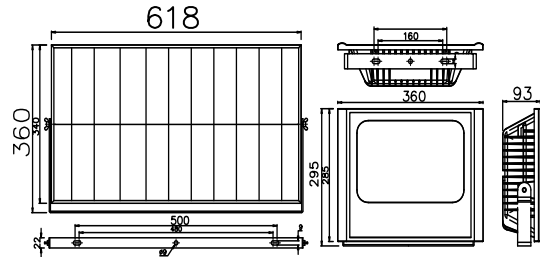

MADPLS-FL200W-B

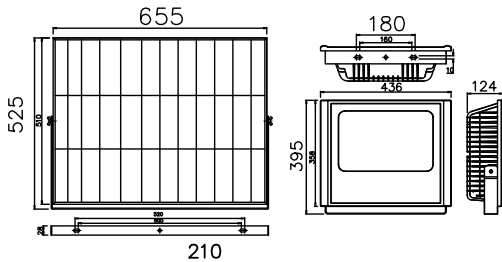

MADPLS-FL300W-B



MADPLS-RC

REMOTE CONTROLLER INSTRUCTION

Mode button:

Mode 1: The light will be on after dusk.

Mode 2: The light will be on at daytime and night time.

4H & 6H button: Hours lasting for the light is on after dusk, then turns off.

ON button: The light is on with mode 1.

OFF button: The light turns off.



MADPLS-FL-12W-5K

Key Features

- 12W Solar LED Flood light
- No AC power cables, no electrical charges
- Die-Casting Aluminium body
- Polycrystalline Solar panel
- Lithium battery
- Build-in dusk to dawn sensor

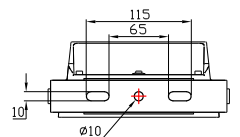
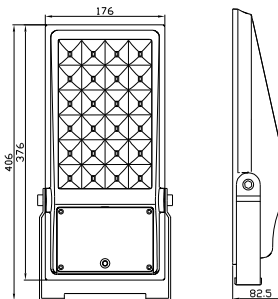

MODEL NUMBER	Wattage	Materials	LED CHIPS	LED Q'ty (pcs)	LUMENS	CCT	Solar Panel	Battery	Charging Time	Discharging Time	CRI	DIMMABLE	Warranty
MADPLS-FL-12W-5K	12W	Die-Casting Aluminium	SMD5730	24	1200lm	5K	5.5V 9.5W	2000mAh	6-8 Hours	10-12 Hours	> 80	No	3 years

LED SOLAR FLOOD LIGHT RANGE



PRODUCT DETAILS



MADPLS-FL50W-6K/G/S



MADPLS-FL100W-6K/G/S



MADPLS-FL150W-6K/G/S

Key Features

- Solar LED Flood light
- No AC power cables, no electrical charges
- Polycrystalline Solar panel
- Lithium battery, Remote control
- Build-in Motion sensor
- Build-in dusk to dawn sensor



MODEL NUMBER	Watts	Materials	LED CHIPS	LED Q'ty (pcs)	LUMENS	CCT	Solar Panel	Battery	Charging Time	Discharging Time	CRI	DIMMABLE	Warranty
MADPLS-FL50W-6K/G/S	50W	ABS	SMD5730	60	6000lm	6K	6V 5.5W	3.2V 12Ah	6-8 Hours	10-12 Hours	> 80	Yes	3 years
MADPLS-FL100W-6K/G/S	100W	ABS	SMD5730	120	12000lm	6K	6V 8.5W	3.2V 18Ah	6-8 Hours	10-12 Hours	> 80	Yes	3 years
MADPLS-FL150W-6K/G/S	150W	ABS	SMD5730	180	18000lm	6K	6V 11.5W	3.2V 24Ah	6-8 Hours	10-12 Hours	> 80	Yes	3 years
MADPLS-RC	Remote controller for LED solar street light, batten light and Flood light.												

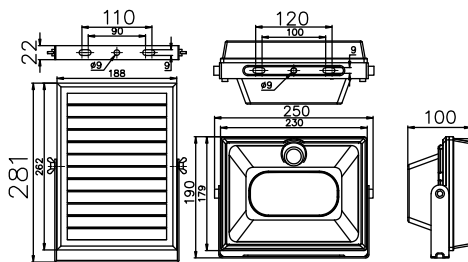

MADPLS-FL50W-6K/G/S

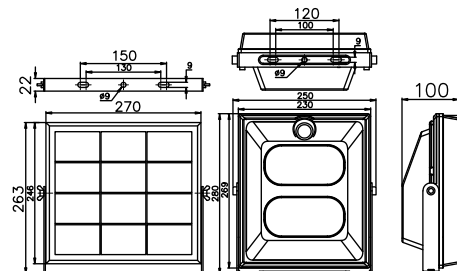

MADPLS-FL100W-6K/G/S

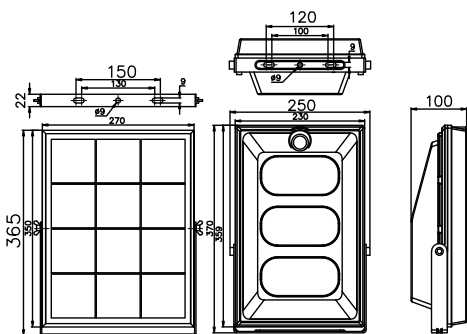

MADPLS-FL150W-6K/G/S



MADPLS-RC

REMOTE CONTROLLER INSTRUCTION

Mode button:

Mode 1: Motion sensor mode, starts with 100% lumen output then standby 30% lumen output if no motion after dusk.

Mode 2: Constant 100% brightness after dusk.

4H & 6H button: Hours lasting for 100% brightness after dusk, then turns off.

ON button: The light is on with mode 1.

OFF button: The light turns off.